

CB106EXT

Trim parts for wall-mounted washbasin mixer
 Parti esterne per miscelatore lavabo a parete
 Parties extérieures pour mitigeur mural de lavabo
 Partes exteriores para monomando de pared
 AP-Teile für Waschtisch-Batterie für Wandmontage
 Afbouwdeel t.b.v. inbouw wastafelmengkraan

hotbath
 italian bathroomware

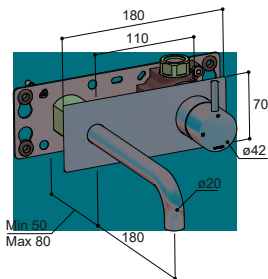

CB106EXT-18

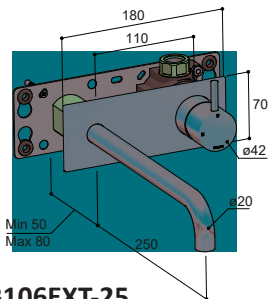

CB106EXT-25





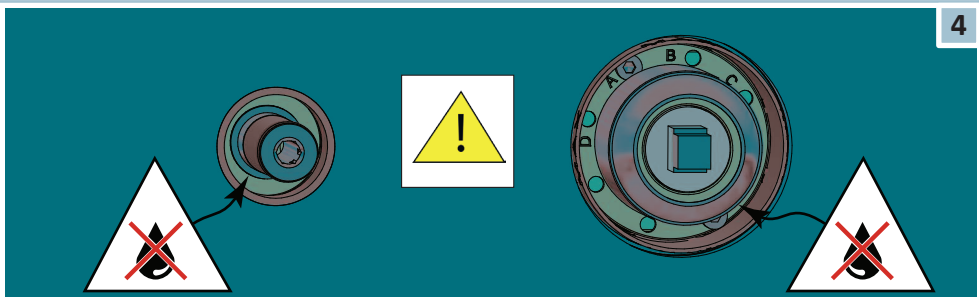
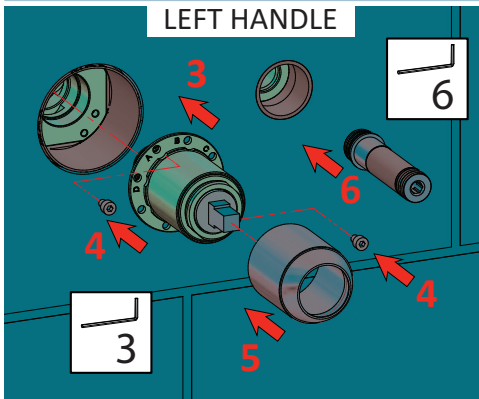
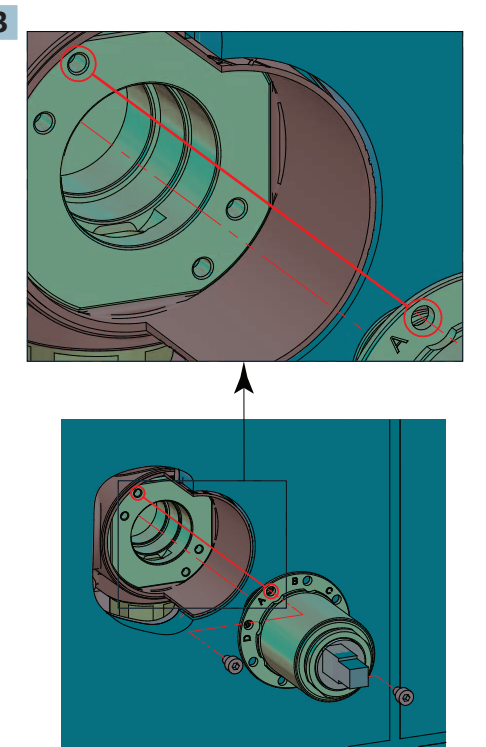
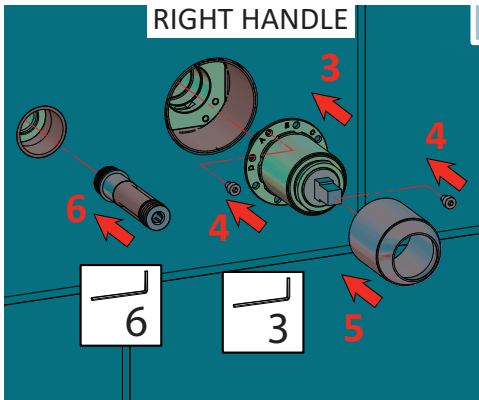
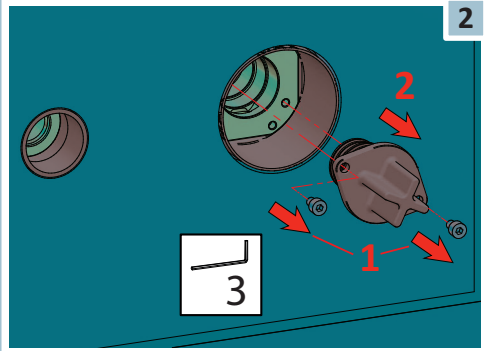
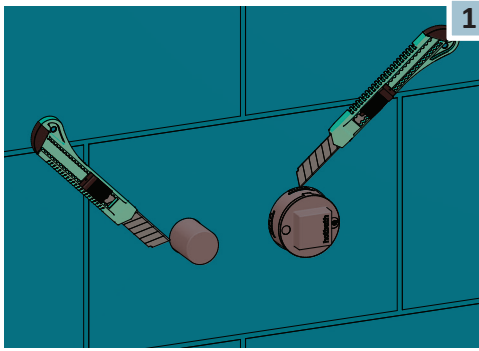

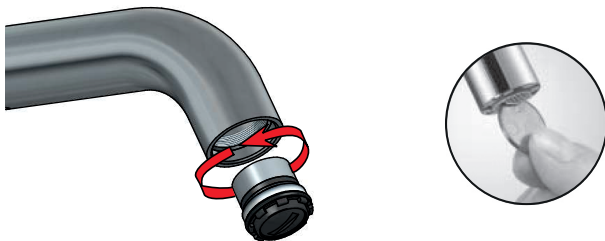
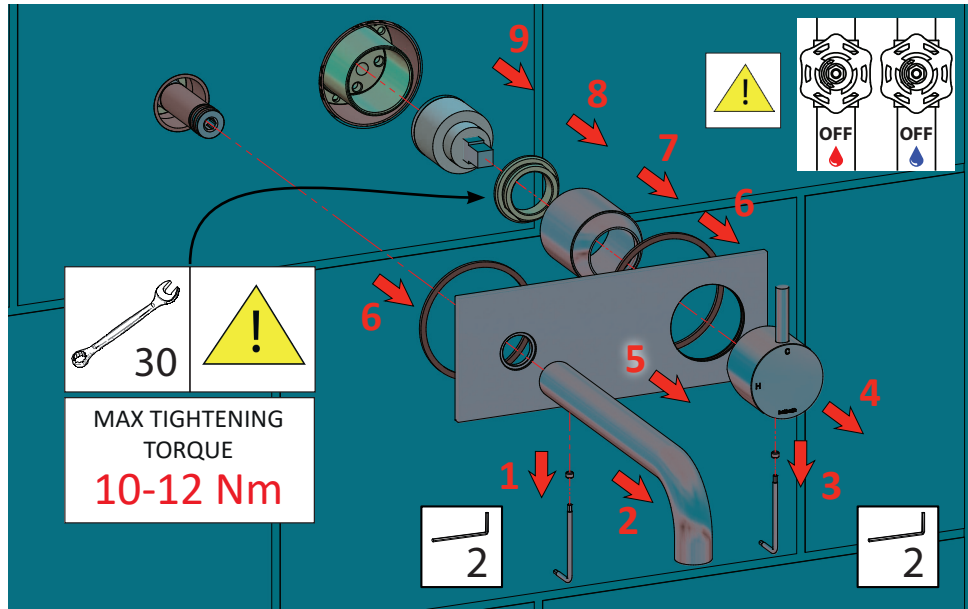
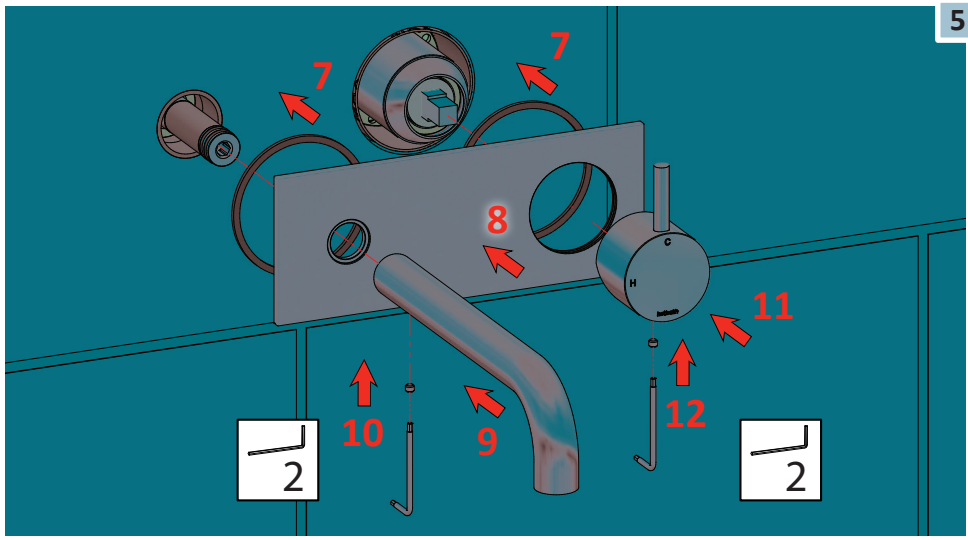

























BEFORE STARTING / PRIMA DI INIZIARE / AVANT DE COMMENCER / ANTES DE EMPEZAR / VOR DEM START / VOORDAT JE BEGINT

<p>P bar</p>	<p>MAX 5 1 MIN</p>	<p>3 1</p>	
<p>T °C</p>	<p>MAX 80°</p>	<p>60° 45°</p>	





CLEANING - PULIZIA - NETTOYAGE - REINIGUNG - LIMPIEZA - REINIGING

			WARNING											
CR CHROME	GN BRUSHED NICKEL	Inoxidable electrolitic finish Finitura elettrolitica inossidabile Finition électrolytique inoxydable Inoxidierbare elektrolytische Ausführung Acabado electrolítico inoxidable Inoxidable elektrolitische afwerking							<input checked="" type="checkbox"/>	<input checked="" type="checkbox"/>	<input checked="" type="checkbox"/>	<input checked="" type="checkbox"/>	<input checked="" type="checkbox"/>	<input checked="" type="checkbox"/>
BB BRUSHED BRASS	BC BRUSHED COPPER	NB NATURAL BRASS	Natural metal finish: patina will form over time Finitura di metallo naturale: si formerà una patina nel tempo Finition en métal naturel: une patine se formera avec le temps Natürliche Metallausführung: eine Patina wird sich mit der Zeit bilden Acabado metálico natural: la patina se formará con el tiempo Natuurlijke metalen afwerking: na verloop van tijd vormt zich patina						<input checked="" type="checkbox"/>	<input checked="" type="checkbox"/>	<input checked="" type="checkbox"/>	<input checked="" type="checkbox"/>	<input checked="" type="checkbox"/>	<input checked="" type="checkbox"/>
	AB AGED BRASS	Aged metal finish: patina will form over time Finitura di metallo invecchiato: si formerà una patina nel tempo Finition en métal vieilli: une patine se formera avec le temps Gealterte Metallausführung: eine Patina wird sich mit der Zeit bilden Acabado de metal envejecido: la patina se formará con el tiempo Verouderde metalen afwerking: na verloop van tijd vormt zich patina							<input checked="" type="checkbox"/>	<input checked="" type="checkbox"/>	<input checked="" type="checkbox"/>	<input checked="" type="checkbox"/>	<input checked="" type="checkbox"/>	<input checked="" type="checkbox"/>
BL MATT BLACK	WH MATT WHITE	Varnished finish: subject to scratches if not properly handled Finitura verniciata: soggetta a deterioramento se non trattata correttamente Finition vernie: sujette aux rayures si ne pas traitée correctement Lackierte Ausführung: Kratzer bei unsachgemäßer Behandlung Gelakte afwerking: gevoelig voor krassen als er niet goed mee wordt omgegaan							<input checked="" type="checkbox"/>	<input checked="" type="checkbox"/>	<input checked="" type="checkbox"/>	<input checked="" type="checkbox"/>	<input checked="" type="checkbox"/>	<input checked="" type="checkbox"/>
BK BLACK CHROME	AI AGED IRON	Plated finish: subject to scratches if not properly handled Finitura placcata: soggetta a deterioramento se non trattata correttamente Finition plaquée: sujette aux rayures si ne pas traitée correctement Plattierte Ausführung: Kratzer bei unsachgemäßer Behandlung Geplateerde afwerking: gevoelig voor krassen als er niet goed mee wordt omgegaan							<input checked="" type="checkbox"/>	<input checked="" type="checkbox"/>	<input checked="" type="checkbox"/>	<input checked="" type="checkbox"/>	<input checked="" type="checkbox"/>	<input checked="" type="checkbox"/>
BBP BRUSHED BRASS PVD	BCP BRUSHED COPPER PVD	NBP NATURAL BRASS PVD	Inoxidable PVD finish Finitura PVD inossidabile Finition PVD inoxydable Inoxidierbare PVD Ausführung Acabado PVD inoxidable Inoxidable PVD afwerking						<input checked="" type="checkbox"/>	<input checked="" type="checkbox"/>	<input checked="" type="checkbox"/>	<input checked="" type="checkbox"/>	<input checked="" type="checkbox"/>	<input checked="" type="checkbox"/>

TERMS OF SALE AND WARRANTY
CONDIZIONI DI VENDITA E GARANZIA
CONDITIONS DE VENTE ET GARANTIE

CONDICIONES DE VENTA Y GARANTÍA
VERKAUFSBEDINGUNGEN UND GARANTIE
VERKOOP- EN GARANTIEVOORWAARDEN

NETHERLANDS
BELGIUM
LUXEMBOURG
UK AND IRELAND

ALL COUNTRIES
(EXCEPTED BENELUX, UK AND IRELAND)

<https://www.hotbath.nl/garantie>

<https://hotbath.it/en/termsforsale>



Hotbath B.V.
Nieuwland Parc 210
2952 DC Alblasserdam
Nederland
E info@hotbath.nl
W hotbath.nl



Hotbath Srl
Via Marco Polo 135/D
I-55049 Viareggio
Italy
E info@hotbath.it
W hotbath.it

hotbath
italian bathroomware